



# InfiniHost<sup>®</sup> III Lx PCI Express x8 HCA Adapter Card User's Manual

P/N: MHES18-XSC, MHES18-XTC, MHGS18-XSC, MHGS18-XTC  
Rev 1.05

© Copyright 2008. Mellanox Technologies, Inc. All Rights Reserved.

Mellanox Technologies, InfiniHost<sup>®</sup>, and ConnectX<sup>®</sup> are registered trademarks for Mellanox Technologies, Inc. All other marks and names mentioned herein may be trademarks of their respective companies.

InfiniHost III Ex PCI Express Low Profile Adapter Card User's Manual

Document Number: 2311

Mellanox Technologies, Inc.  
2900 Stender Way  
Santa Clara, CA 95054  
U.S.A.  
[www.mellanox.com](http://www.mellanox.com)

Tel: (408) 970-3400  
Fax: (408) 970-3403

Mellanox Technologies Ltd.  
PO Box 586 Hermon Building  
Yokneam 20692  
Israel

Tel: +972-4-909-7200  
Fax: +972-4-959-3245

# Table of Contents

<b>Table of Contents</b>	<b>3</b>
<b>List of Tables</b>	<b>4</b>
<b>List of Figures</b>	<b>5</b>
<b>Revision History</b>	<b>6</b>
<b>About this Manual</b>	<b>7</b>
<b>Chapter 1 Overview</b>	<b>9</b>
1.1 Adapter Cards	9
1.2 Mellanox Part Numbering Legend	10
1.3 Finding the GUID and Serial Number on the Adapter Cards	11
<b>Chapter 2 HCA Card Installation</b>	<b>12</b>
2.1 Hardware and Software Requirements	12
2.2 Installation Instructions	12
2.3 Safety Warnings	13
<b>Chapter 3 Driver Software and Firmware</b>	<b>14</b>
3.1 Driver Software	14
3.2 Updating HCA Card Firmware	14
3.3 Single HCA Card Firmware Update	14
3.4 HCA Card Firmware Update as Part of a Cluster Firmware Update	14
3.5 Customized HCA Card Firmware Update (OEM Only)	15
<b>Chapter 4 Adapter Card Interfaces</b>	<b>16</b>
4.1 I/O Interfaces	16
4.2 Power	18
4.3 Memory	18
4.4 VPDs	19
<b>AppendixA Specifications</b>	<b>22</b>
A.1 Board Mechanical Drawing and Dimensions	22
A.2 EMC Certification Statements	23
A.3 MHES18-X[ST]C (IB SDR) MHGS18-X[ST]C (IB DDR) Specifications	25
<b>AppendixB Interface Connectors Pinout</b>	<b>26</b>
B.1 I2C-Compatible Connector Pinout	26
B.2 InfiniBand Connector Pinout	26
B.3 PCI Express x8 Connector Pinout	27
<b>AppendixC Replacing a Tall Bracket With a Short Bracket on HCA Cards</b>	<b>28</b>
C.1 Removing Tall Bracket	28
C.2 Assembling Short Bracket	30
<b>AppendixD Avertissements de sécurité d'installation</b>	<b>32</b>

## *List of Tables*

<b>Table 1:</b>	<b>Revision History Table</b>	<b>6</b>
<b>Table 2:</b>	<b>Documents List</b>	<b>7</b>
<b>Table 3:</b>	<b>HCA Cards</b>	<b>9</b>
<b>Table 4:</b>	<b>Mellanox HCA Cards Part Numbering Key</b>	<b>10</b>
<b>Table 5:</b>	<b>Hardware and Software Requirements</b>	<b>12</b>
<b>Table 6:</b>	<b>Firmware Images for InfiniHost III Lx PCI Express HCA Cards</b>	<b>14</b>
<b>Table 7:</b>	<b>LEDs</b>	<b>17</b>
<b>Table 8:</b>	<b>Jumper Configuration</b>	<b>18</b>
<b>Table 9:</b>	<b>VPD Layout for MHES18 X[ST]C</b>	<b>19</b>
<b>Table 10:</b>	<b>VPD Layout for MHGS18 X[ST]C</b>	<b>20</b>
<b>Table 11:</b>	<b>HCA Cards Certification Status</b>	<b>23</b>
<b>Table 12:</b>	<b>I2C-compatible Connector Pinout</b>	<b>26</b>
<b>Table 13:</b>	<b>Connector Pin Name and Number to Signal Name Correspondence</b>	<b>27</b>

## *List of Figures*

<b>Figure 1: HCA Card Component Side</b>	<b>9</b>
<b>Figure 2: Card Product Label</b>	<b>11</b>
<b>Figure 3: InfiniHost III CX4 interface</b>	<b>16</b>
<b>Figure 4: Physical and Logical Link Indications</b>	<b>17</b>
<b>Figure 5: I2C Connector</b>	<b>17</b>
<b>Figure 6: Flash Jumper</b>	<b>18</b>
<b>Figure 7: Schematics for MH[EG]18-X{ST}C</b>	<b>22</b>
<b>Figure 8: I2C-Compatible Connector Plug and Pinout</b>	<b>26</b>
<b>Figure 9: InfiniBand CX4 Connector Pinout</b>	<b>26</b>
<b>Figure 10: CX4 Connector in a Tall Bracket</b>	<b>28</b>
<b>Figure 11: Connector Retention Clip</b>	<b>28</b>
<b>Figure 12: Extracting Connector Clip</b>	<b>29</b>
<b>Figure 13: Unscrew Bracket Screws</b>	<b>29</b>
<b>Figure 14: Rotate the Bracket to Detach it From the Card</b>	<b>30</b>
<b>Figure 15: Attach Bracket onto Card using Screws</b>	<b>30</b>
<b>Figure 16: Sliding Connector Clip Evenly</b>	<b>31</b>
<b>Figure 17: Assembled Short Bracket View</b>	<b>31</b>

# Revision History

This document was printed on August 12, 2008 3:48 pm.

Table 1 - Revision History Table

Rev	Date	Comments/Changes
1.05	August 2008	Removed watermark Removed "Confidential" from footer. Added copyright info to page 2 Replaced safety warnings with more encompassing warnings Added translation of warnings into French in appendix.
1.04	May 2008	Added MIC, C-Tick, Cb report, and CTUVUS Certs to Appendix A Cert Table
1.03	March 2008	Added MIC statement and new graphics for I2C and Flash Jumper Added 2 columns to the Cert Table in Appendix A
1.02	June 2007	Corrected the Maximum Power number for MHES18-XSC in Section A.3, "MHES18-X[ST]C (IB SDR) MHGS18-X[ST]C (IB DDR) Specifications," on page 25 as follows: Old Maximum Power: 4.2[W] New Maximum Power: 3.5[W]
1.01	December 2006	Added EMC VCCI statements to Appendix A, "Specifications," on page 22
1.00	November 2006	First revision

# About this Manual

This *User's Manual* describes Mellanox Technologies MHES18-X[TS]C InfiniHost III Lx PCI Express x8 HCA Adapter cards. It provides details as to the interfaces of the board, specifications, required software and firmware for operating the board, and relevant documentation.

## Intended Audience

This manual is intended for the installer and user of these cards.

The manual assumes basic familiarity with Infiniband® networks and architecture specifications.

## Related Documentation

Table 2 - Documents List

<i>InfiniHost III Programmer's Reference Manual</i> Document no. 2248PM	A reference describing the interface used by developers to write a driver for MemFree Mellanox InfiniHost III devices.
<i>InfiniHost III Lx MT25204 Hardware Reference Manual</i> Document no. 2131HM	Reference for hardware engineers responsible for designing systems and boards incorporating InfiniHost III Lx components.
<i>Mellanox Firmware Tools (MFT) User's Manual</i> Document no. 2204UG	User's Manual describing the set of MFT firmware management tools for a single InfiniBand node. See <a href="http://www.mellanox.com">http://www.mellanox.com</a> under 'Firmware' downloads.
<i>Mellanox MST User's Manual</i> Document no. 2125SM	This manual describes various tools and utilities, included in the Mellanox Software Tools (MST) package, for accessing, burning firmware, and tracing Mellanox silicon devices.
<i>InfiniBand Administration (IBADM) Package User's Manual</i> Document no. 2130UM	User's Manual describing the utilities included in the IBADM tools package for system administration of an InfiniBand cluster. See <a href="http://www.mellanox.com">http://www.mellanox.com</a> under 'Management Tools'.
<i>VAPI HCA Device Driver Release Notes</i> Version 4.0.0 or later	InfiniHost III device driver release notes
<i>IB Specifications Release 1.0.a</i>	Infiniband Architecture Specifications
<i>PCI Express 2.0 Specifications</i>	Industry Standard PCI Express 2.0 Card Electromechanical Specification, Rev 1.3.

## Online Resources

- Mellanox Technologies Web pages: <http://www.mellanox.com>
- Mellanox Technologies Firmware download Web page: <http://www.mellanox.com/> under Firmware downloads
- Mellanox Technologies Document Distribution System (DDS): <http://docs.mellanox.com> (requires a customer login account)

---

## Document Conventions

When discussing memory sizes, MB and MBytes are used in this document to mean size in mega bytes. The use of Mb or Mbits (small b) indicates size in mega bits.



# 1 Overview

This document is a *User's Manual* for Mellanox Technologies host channel adapter (HCA) Cards based on the MT25408 InfiniHost® III Lx HCA integrated circuit device. The cards described in this manual have the following main features:

- IBTA v1.2 compliant
- Single 4X InfiniBand copper ports for connecting InfiniBand traffic (4X IB connectors)
- PCI Express expansion board with an x8 edge connector compatible to the PCI Express 1.0a specification
- 'Media detect circuit' with powered connectors supporting the use of active cables and external PHY fiber solutions
- EU Restriction of Hazardous Substances (RoHS) compliant
- SDR/DDR4X IB10Gb/s (SDR) or 20Gb/s (DDR)(Fiber solutions run at SDR only)
- 
- Two bracket heights: short or tall

## 1.1 Adapter Cards

Table 3 lists the InfiniBand HCA cards described in this manual.

Table 3 - HCA Cards

Ordering Part Number (OPN)	IB SDR / DDR	Short / Tall Bracket	RoHS Compliance	HCA IC Part Number	HCA Card Photo
MHES18-XSC	SDR	Short	RoHS-R5	MT25204A0-FCC	Figure 1: HCA Card Component Side 
MHES18-XTC		Tall			
MHGS18-XSC	DDR	Short	RoHS-R5	MT25204A0-FCC-D	
MHGS18-XTC		Tall			

## 1.2 Mellanox Part Numbering Legend

Table 4 describes the Mellanox Technologies adapter cards part numbering legend.

Table 4 - Mellanox HCA Cards Part Numbering Key

HCA Card OPN MHTS#I-XBR	Field	Decoder
M	Mellanox Technologies	
H	Adapter Type	H = InfiniBand Host Channel Adapter, N = Ethernet Network Interface Card, S = Express Module
T	Media	E=CX4 SDR, G=CX4 DDR, J=CX4 QDR, K=XFP SR, M=SFP+ SR, N=SFP+ LRM, O=SFP+ LR, Q=QSFP QDR, R=QSFP DDR, T=UTP
S	Silicon	H = ConnectX, S = InfiniHost III Lx <sup>®</sup> , T= InfiniHost <sup>®</sup> , A = InfiniHost III Ex (Arbel), S = Infini-Host III Lx (Sinai), T = InfiniHost (Tavor)
#	# ports	1 = 1, 2 = 2,
I	Host Interface	X = PCI-X, 4 = PCIe x4, 8 = PCIe x8, 9 = PCIe (SerDes @ 5.0 GT/s)
G	Generation	<blank> = Initial product generation
-	Separator	
X	Memory Size	X = MemFree, 1=128MB, 2=256MB, 3=512MB
B	Bracket	S = Short, T = Tall, N = None
R	RoHS	<blank> = non RoHS, C = RoHS w/ Exemption, R = RoHS Lead-Free

For example, the part number MHES14-XSC describes Mellanox Technologies' InfiniHost III™ IB HCA card with single CX4 port, a PCIe2.0 x4 2.5GT/s interface, no on-board memory (mem-free), a short PCI bracket, and RoHS R5 compliance. Using the legend,

- field M = M to indicate a Mellanox Technologies product,
- field H = H to indicate an InfiniBand Adapter Card,
- field T = E to indicate 10GBASE-CX4,
- field S = S to indicate InfiniHostIII
- field # = 1 to indicate one port,
- field I = 8 to indicate PCI Express 2.0 x8 running at 2.5GT/s,
- field X = X to indicate no on-board memory,
- field B = S to indicate a short bracket, and
- field R = C to indicate RoHS R5 (w/ Exemptions) compliance

### 1.3 Finding the GUID and Serial Number on the Adapter Cards

All Mellanox HCA adapter cards have a label on the printed side of the adapter card that has the card serial number and the card GUID.

Figure 2: Card Product Label



# 2 HCA Card Installation

## 2.1 Hardware and Software Requirements

Before installing the HCA Adapter card, please make sure that the system meets the hardware and software requirements listed in Table 5.

Table 5 - Hardware and Software Requirements

Requirement	Description
Hardware	PCI Express x8 slot or x4 slot with x8 connector
Software Operating Systems/Distributions	<ul style="list-style-type: none"><li>• For Windows see <a href="https://docs.mellanox.com/dm/WinIB/ReadMe.html">WinIB ReadMe</a> at <a href="https://docs.mellanox.com/dm/WinIB/ReadMe.html">https://docs.mellanox.com/dm/WinIB/ReadMe.html</a></li><li>• For Linux see Mellanox OpenFabrics Enterprise Distribution (OFED) software package available via the Mellanox OpenFabrics Web site <a href="http://www.mellanox.com/products/ofed.php">http://www.mellanox.com/products/ofed.php</a></li></ul>

## 2.2 Installation Instructions

Read all installation instructions before connecting the equipment to the power source. Please consult the host machine documentation for instructions on how to install a PCI Express card.

### 2.2.1 Installation Instructions as per Host Machine

The adapter cards listed in Table 3 on page 9 are standard PCI Express 8 cards each with a standard x8 edge connector. Please consult the host machine documentation for instructions on how to install a PCI Express card.

## 2.3 Safety Warnings

### 1. Installation Instructions



Read all installation instructions before connecting the equipment to the power source.

### 2. Over-temperature



This equipment should not be operated in an area with an ambient temperature exceeding the maximum recommended: 55°C (131°F). Moreover, to guarantee proper air flow, allow at least 8cm (3 inches) of clearance around the ventilation openings.

### 3. During Lightning - Electrical Hazard



During periods of lightning activity, do not work on the equipment or connect or disconnect cables.

### 4. Copper InfiniBand Cable Connecting/Disconnecting



Copper InfiniBand cables are heavy and not flexible, as such they should be carefully attached to or detached from the connectors. Refer to the cable manufacturer for special warnings and instructions.

### 5. Equipment Installation



This equipment should be installed, replaced, or serviced only by trained and qualified personnel.

### 6. Equipment Disposal



Disposal of this equipment should be in accordance to all national laws and regulations.

### 7. Local and National Electrical Codes



This equipment should be installed in compliance with local and national electrical codes.

# 3 Driver Software and Firmware

## 3.1 Driver Software

For Linux, download and install the latest OpenFabrics Enterprise Distribution (OFED) software package available via the Mellanox OpenFabrics Web site at <http://www.mellanox.com/products/ofed.php>. Follow the installation instructions included in the download package.

For Windows, download the appropriate software from <https://docs.mellanox.com/dm/WinIB/ReadMe.html>.

## 3.2 Updating HCA Card Firmware

Each HCA card is shipped with the latest version of qualified firmware at the time of manufacturing. Firmware is updated occasionally, and the most recent firmware can be obtained from <http://www.mellanox.com> through the 'Firmware' downloads link.

## 3.3 Single HCA Card Firmware Update

Firmware can be updated on the standalone single card using the **flint** tool of the *Mellanox Firmware Tools (MFT)* package. This package is available for download, along with its user's manual, from the single HCA card firmware update page. See <http://www.mellanox.com> under 'Firmware' downloads.

A firmware binaries table lists a binary file per HCA card. The file name of each such binary is composed by combining the firmware name, the firmware release version, and the card part number. See Table 6. Please contact your

Table 6 - Firmware Images for InfiniHost III Lx PCI Express HCA Cards

Type of HCA Card	PCI DevID (Decimal) & Firmware Image Name	Examples
Mem-free	PCI DevID: 25204  Firmware: fw- 25204	<i>fw-25204-1_1_0-MHES18-XSC_A2.bin.zip</i> is the firmware binary of firmware fw-25204 version 1.1.0, for the HCA card MHES18-XSC Rev A2

assigned Field Application Engineer if you cannot find the firmware binary for your adapter card. This may happen if the product is not yet available for general distribution.

## 3.4 HCA Card Firmware Update as Part of a Cluster Firmware Update

If the HCA card is part of an InfiniBand cluster, its firmware can be updated as part of the entire cluster firmware update, using the **ibfwmgr** tool of the IB administration (IBADM) tools package. IBADM is available for download as part of IB stack distributions such as IB Gold and OFED<sup>1</sup> available via <http://www.mellanox.com>. See 'Firmware Downloads' under the same webpage for cluster update instructions.

1. Currently, only the Linux distributions support updating firmware for an entire InfiniBand cluster.

### 3.5 Customized HCA Card Firmware Update (OEM Only)

Note: The procedure described in this section is normally *not* needed and applies to OEMs only.

To create a customized firmware binary, the firmware image in MLX format needs to be downloaded along with the *MFT* tools package. See <http://www.mellanox.com> under 'Firmware Downloads' for customized firmware update instructions.

# 4 Adapter Card Interfaces

## 4.1 I/O Interfaces

Each HCA card includes the following interfaces:

- One 4X InfiniBand copper connector
- PCI Express x8 edge connector
- I/O panel LEDs
- I<sup>2</sup>C compatible connector (for debug)

### 4.1.1 InfiniBand Interface

The InfiniHost III<sup>®</sup>LX (MT25204 Third Generation) device is compliant with the *InfiniBand Architecture Specification, Release 1.2*. It has one compliant 4X InfiniBand port, having four Tx/Rx pairs of SerDes. Each of the HCA cards (listed in Table 3 on page 9) based on this device provides access to this port by means of an InfiniBand connector for external InfiniBand copper cables. These cards are also compliant with the IBTA specification 1.2.

Figure 3: InfiniHost III CX4 interface





Each of the HCA cards is embedded with a 'media detect circuit' that supports active cables and external InfiniBand fiber solutions to be connected to the InfiniBand port connectors. Fiber Solutions require the use of active media converters.

The ConnectX InfiniHost III<sup>®</sup> IB HCA adapter cards support the PCI Express 1.0a x4 interface, 1.0a compatible. The cards can be either a master initiating the PCI Express bus operations or a slave responding to PCI bus operations.

### 4.1.2 PCI Express Interface

The InfiniHost III Lx (MT25204) device has eight Tx/Rx pairs of SerDes providing for a PCI Express x8 interface, version 1.0a compatible. The device can be either a master initiating the PCI Express bus operations or a slave responding to PCI bus operations. The PCI Express bus can connect to either a host CPU in an HCA application or to an I/O device (such as Gigabit Ethernet) when used as a Target Channel Adapter.

### 4.1.3 LED Assignment

The board has two LEDs located on the I/O panel. The green LED, when lit, indicates that the InfiniBand driver is running and a valid physical connection between nodes exists. If the green LED is blinking, it indicates a problem with the physical link. The yellow LED when lit, indicates a valid data activity link, this is the logical link. The yellow LED illuminates when the InfiniBand network is discovered over the physical link. A valid data activity link without data transfer is designated by a constant yellow LED indication. A valid data activity link with data transfer is designated by a blinking yellow LED indication. If the LEDs are not active, either the physical link or the logical link (or both) connections have not been established.

Figure 4: Physical and Logical Link Indications

Table 7 - LEDs

Port Number	LED Name
Port 1	Physical Link - Green Constant on indicates a good physical link Blinking indicates a problem with the Physical link
	Data Activity - Yellow Blinking indicates Data Transfer Constant on indicates no Data Transfer



Note: The short bracket has the same port and LED footprint as the tall bracket.

### 4.1.4 I<sup>2</sup>C Compatible Interface

A three-pin header on the HCA card is provided as the I<sup>2</sup>C compatible interface. See Figure 7 on page 22 for the location on the board.

Figure 5: I<sup>2</sup>C Connector



## 4.2 Power

All adapter cards receive power from the PCI Express Edge connector. All other required power voltages are generated by on-board switch mode regulators. See “Specifications” on page 22.

## 4.3 Memory

The HCA cards support multiple memory devices through the PCIeExpress, Flash, and I2C-compatible interfaces.

### 4.3.1 System Memory

Each of the HCA cards utilizes the PCI Express interface to store and access IB fabric connection information and packet data on the system memory.

### 4.3.2 Flash

Each of the HCA cards includes one 2MB SPI Flash device (P/N M25P16 by ST Microelectronics) accessible via the Flash interface of the MT25408 InfiniHost III Lx device.

There is a jumper on each adapter card that indicates to the device whether an on-board Flash device exists (or is to be used). Table 8 provides information on this jumper. See Figure 7 on page 22 for the jumper location.

Table 8 - Jumper Configuration

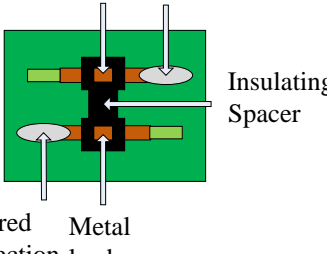
Description	Option	Card Default Configuration	Comments
Flash present/ not present	connection open – Flash present connection shorted – Flash not present  Figure 6: Flash Jumper Metal Soldered lead Connection  	connection open – Flash present	Header 1x2

### 4.3.3 EEPROM

Each board incorporates an EEPROM that is accessible through the I2C-compatible interface. The EEPROM is used for storing the Vital Product Data (VPD). The VPD format adheres to the *PCI Local Bus specification rev 2.3 VPD* definition. The EEPROM capacity is 512 bytes.

## 4.4 VPDs

The PCI VPD (Vital Product Data) layout, for each of the described Mellanox Technologies InfiniHost III<sup>®</sup> Lx cards, complies with the format defined in the *PCI 2.3 Specification, Appendix I*. All InfiniHost III Lx cards share the same PCI VPD layout.

Table 9 - VPD Layout for MHES18 X[ST]C

Offset (Decimal)	Item	Value	Format	Description
0	Large Resource Type ID String Tag (0x02)	0x82		
1	Length	0x7		
3	Data	“Cheetah”	Alphanumeric	
10	Large Resource Type VPD-R Tag (0x10)	0x90		
11	Length	0x4F		
13	VPD Keyword	“PN”	Numbers	Add in Card Part Number
15	Length	0x15		
16	Data	“PN”		
37	VPD Keyword	“EC”	Alphanumeric	Engineering Change Level of the card (rev)
39	Length	0x2		
40	Data	“B1”		PCB revision
42	VPD Keyword	“SN”	Alphanumeric	Serial Number
44	Length	0x18		
45	Data	“MTYYW-WPSSSSS”		according to the board label
69	VPD Keyword	“V0”		Misc Information
71	Length	0x10		
72	Data	“PCIe x8”		
88	VPD Keyword	“RV”		
90	Length	0x1		
91	Data	Checksum		
92	Large Resource Type VPD-W Tag (0x11)	0x91		
93	Length	0xA0		
95	VPD Keyword	“V1”		EFI Driver version
97	Length	0x6		
98	Data	“N/A”	Number	
104	VPD Keyword	“YA”		Asset Tag
106	Length	0x20		
107	Data	“N/A”	Alphanumeric	“N/A”
139	VPD Keyword	“RW”		Remaining read/write area
141	Length	0x71		
142	Data	Reserved (0x00)		
255	Small Resource Type END Tag (0x11)	0x78		

Table 9 - VPD Layout for MHES18 X[ST]C

Offset (Decimal)	Item	Value	Format	Description
256	Mellanox Read Only Mask	0x0...0	Numbers	
351	Mellanox Read/Write Mask	0x1...1	Numbers	
511	Mellanox Read Only Mask	0x0	Numbers	

Table 10 - VPD Layout for MHGS18 X[ST]C

Offset (Decimal)	Item	Value	Format	Description
0	Large Resource Type ID String Tag (0x02)	0x82		
1	Length [7:0] LSB	0xB		
2	Length [15:8] MSB	0x0		
3	Data	Cheetah DDR	STR	
14	Large Resource Type VPD-R Tag (0x10)	0x90		
15	Length [7:0] LSB	0x4F		
16	Length [15:8] MSB	0x00		
17	VPD Keyword	PN	STR	Add in Card Part Number
19	Length	0x15		
20	PN	PN	%STR_SPC	
41	VPD Keyword	EC	STR	Engineering Change Level of the card (rev)
43	Length	0x2		
44	Revision	RV	%STR	PCB revision
46	VPD Keyword	SN	STR	Serial Number
48	Length	0x18		
49	SerialNumber		%STR_SPC	“00..00XXXX..XX”
73	VPD Keyword	V0	STR	Misc Information
75	Length	0x10		
76	Data	PCIe x8	STR_SPC	
92	VPD Keyword	RV	STR	
94	Length	0x1		
95	Data	0,94	%CS0	
96	Large Resource Type VPD-W Tag (0x11)	0x91		
97	Length [7:0] LSB	0x9C		
98	Length [15:8] MSB	0x00		
99	VPD Keyword	V1	STR	EFI Driver version
101	Length	0x6		
102	Data	N/A	STR_SPC	
108	VPD Keyword	YA	STR	Asset Tag
110	Length	0x20		
111	Data	N/A	STR_SPC	“N/A”
143	VPD Keyword	RW	STR	Remaining read/write area
145	Length	0x6D		

Table 10 - VPD Layout for MHGS18 X[ST]C

Offset (Decimal)	Item	Value	Format	Description
146	Data		STR_ZERO	Reserved (0x00)
255	Small Resource Type END Tag (0x11)	0x78		

# Appendix A: Specifications

## A.1 Board Mechanical Drawing and Dimensions

All of the HCA cards covered in this *User's Manual* have the same mechanical drawing and share the same dimensions as depicted in Figure 7.

Note: All dimensions are in millimeters.



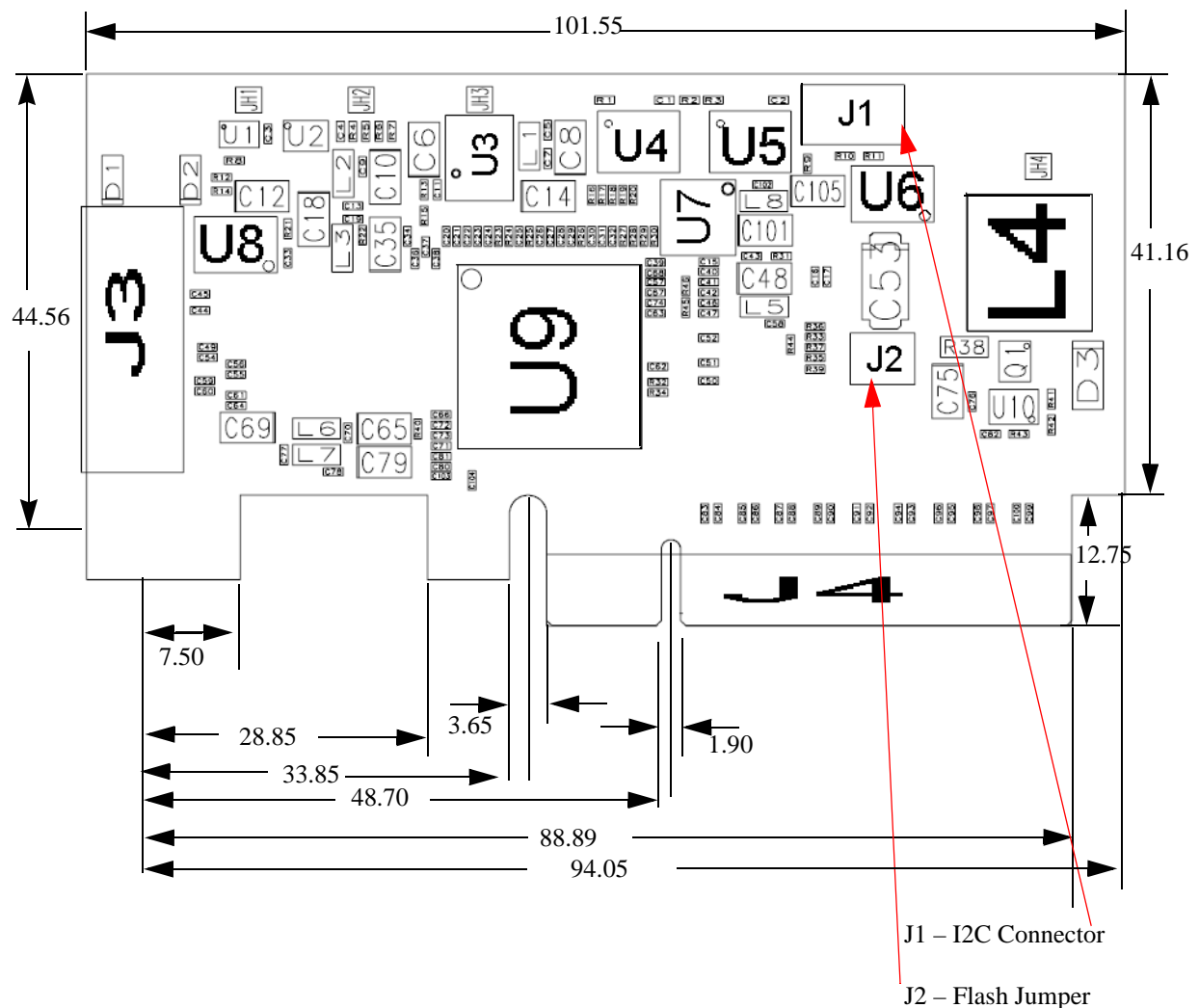









Figure 7: Schematics for MH[EG]18-X{ST}C



## A.2 EMC Certification Statements

A.2.1 Table 11 lists the approved certification status per HCA card in different regions of the world

Table 11 - HCA Cards Certification Status

HCA Card P/N	FCC Class (USA)	EN Class (Europe)	ICES Class (Canada)	C-Tick (Australia and New Zealand)	VCCI (Japan)	MIC (Korea)	CB Report	CTUVUS
MHES18-XSC	Class A	Class A	Class A		Class A	Class A		
MHES18-XTC	Class A	Class A	Class A		Class A	Class A		
MHGS18-XSC	Class A	Class A	Class A		Class A	Class A		
MHGS18-XTC	Class A	Class A	Class A		Class A	Class A		

### A.2.2 FCC Statements (USA)

#### Class A Statements:

##### § 15.21

#### **Statement**

**Warning!** Changes or modifications to this equipment not expressly approved by the party responsible for compliance (Mellanox Technologies) could void the user's authority to operate the equipment.

##### §15.105(a)

#### **Statement**

NOTE: This equipment has been tested and found to comply with the limits for a Class A digital device, pursuant to Part 15 of the FCC Rules. These limits are designed to provide reasonable protection against harmful interference when the equipment is operated in a commercial environment. This equipment generates, uses, and can radiate radio frequency energy and, if not installed and used in accordance with the instruction manual, may cause harmful interference to radio communications. Operation of this equipment in a residential area is likely to cause harmful interference in which case the user will be required to correct the interference at his own expense.

### A.2.3 EN Statements (Europe)

#### EN55022 Class A Statement:

**Warning**

This is a class A product. In a domestic environment this product may cause radio interference in which case the user may be required to take adequate measures.

### A.2.4 ICES Statements (Canada)

#### Class A Statement:

"This Class A digital apparatus complies with Canadian ICES-003.  
Cet appareil numérique de la classe A est conforme à la norme NMB-003 du Canada."

### A.2.5 VCCI Statements (Japan)

#### Class A Statement:

この装置は、情報処理装置等電波障害自主規制協議会（VCCI）の基準に基づくクラスA情報技術装置です。この装置を家庭環境で使用すると電波妨害を引き起こすことがあります。この場合には使用者が適切な対策を講ずるよう要求されることがあります。

(Translation - "This is a Class A product based on the standard of the Voluntary Control Council for Interference by Information Technology Equipment (VCCI). If this equipment is used in a domestic environment, radio interference may occur, in which case the user may be required to take corrective actions.")



### A.3 MHES18-X[ST]C (IB SDR) MHGS18-X[ST]C (IB DDR) Specifications

Physical		Power and Environmental	
Size:	54mm x 102mm (2.13 in. X 4 in.)	Voltage:	3.3V
Air Flow:	200LFM @55C	Maximum Power:	3.5W
10Gb/s Connector:	Amphenol InfiniBand MicroGigaCN / Emcore (Fiber Channel)	Temperature:	0 to 55 Celsius
Protocol Support		Regulatory	
InfiniBand:	Auto-Negotiation 10Gb/s, 2.5Gb/s	EMC:	FCC 47 CFR part 15:2005, subpart B, class A
QoS:	4 InfiniBand Virtual Lanes for the 4X port		ICES-003:2004 Issue 4, class A
RDMA Support:	Yes		VCCI V-3/2005.04, class A
			MIC class A
			EN 55022:1998+A1:2000+A2:2003 class A, EN 61000-3-2:2000+A2:2005, EN61000-3-3:1995+A1:2001, EN 55024:1998 + A1:2001+A2:2003 standards, harmonized under EMC Directive 89/336/EEC;
			AS/NZS 3548
		Safety:	IEC/EN 60950-1:2001
			ETSI EN 300 019-2-2
			UL 60950-1:2003 R7.06
			CAN/CSA-C22.2 No.60950-1-03
		Environmental:	IEC 60068-2- 64, 29, 32
		RoHS:	RoHS-R5

# Appendix B: Interface Connectors Pinout

## B.1 I<sup>2</sup>C-Compatible Connector Pinout

Figure 7: I2C-Compatible Connector Plug and Pinout

Table 12 - I2C-compatible Connector Pinout

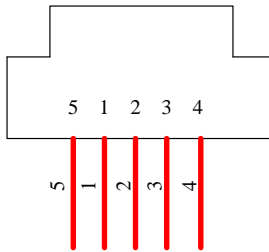

Connector Pin Number	HCA Signal Name
1	SPSDA
2	SPSCL
3	GND
4	NC
5	NC

## B.2 InfiniBand Connector Pinout

Figure 8: InfiniBand CX4 Connector Pinout

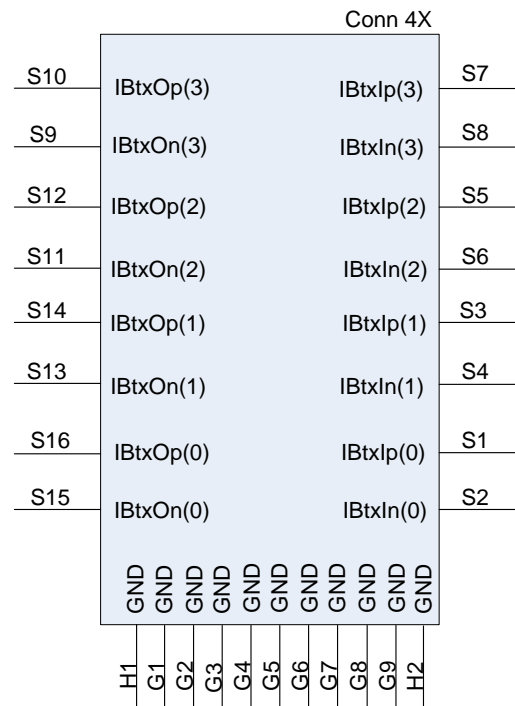

Table 13 - Connector Pin Name and Number to Signal Name Correspondence

Connector Pin Number	Connector Pin Name	IB Port A Signal Name
S1	IBtxIp(0)	Rx_A1
S2	IBtxIn(0)	Rx_A0
S3	IBtxIp(1)	Rx_A3
S4	IBtxIn(1)	Rx_A2
S5	IBtxIp(2)	Rx_A5
S6	IBtxIn(2)	Rx_A4
S7	IBtxIp(3)	Rx_A7
S8	IBtxIn(3)	Rx_A6
S9	IBtxOn(3)	Tx_A6
S10	IBtxOp(3)	Tx_A7
S11	IBtxOn(2)	Tx_A4
S12	IBtxOp(2)	Tx_A5
S13	IBtxOn(1)	Tx_A2
S14	IBtxOp(1)	Tx_A3
S15	IBtxOn(0)	Tx_A0
S16	IBtxOp(0)	Tx_A1
G1-G6, G9, H1-H2	Signal Ground	GND
G7 <sup>1</sup>	Sense-3.3V	SENSE_P1
G8	Vcc	MC_POWER_P1

1. The Sense-3.3V signal is used to enable the Vcc power supply pin (G8) used to provide power to the active media adapter.

## B.3 PCI Express x8 Connector Pinout

These cards use a standard PCI Express x8 edge connector and the PCI Express x8 standard pinout according to the PCI Express 1.0a specification.

## *Appendix C: Replacing a Tall Bracket With a Short Bracket on HCA Cards*

This appendix provides instructions on how to remove the tall bracket of a standard Mellanox Technologies HCA card and replace it with a short one. It includes the following sections:

- “Removing Tall Bracket”
- “Assembling Short Bracket”

Figure 10 shows the bracket-side view of an HCA card.

Figure 9: CX4 Connector in a Tall Bracket



### **C.1 Removing Tall Bracket**

Figure 10 shows a connector retention clip and the designated names of its sections.

Figure 10: Connector Retention Clip

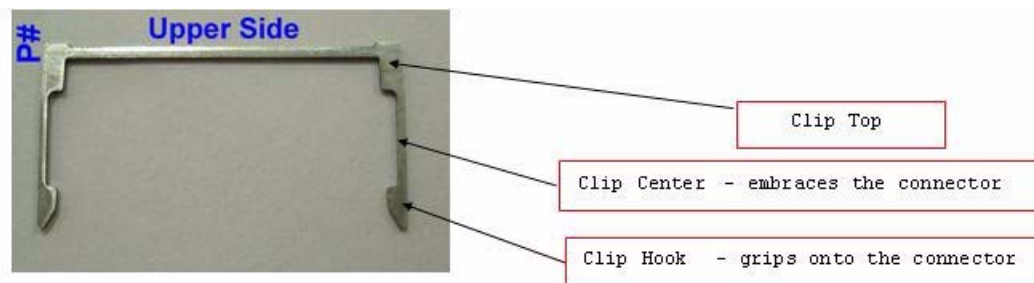

- 1 Using a small flat head screwdriver, gently push up one hook of a connector’s clip toward the connector’s top side as shown in Figure 11 on page 29 (a).
2. Then push the other hook. With both hooks unlatched push the clip towards the connector’s top side - see Figure 11 (b). Finally, pull the clip away from the bracket - see Figure 11 (c).

Figure 11: Extracting Connector Clip

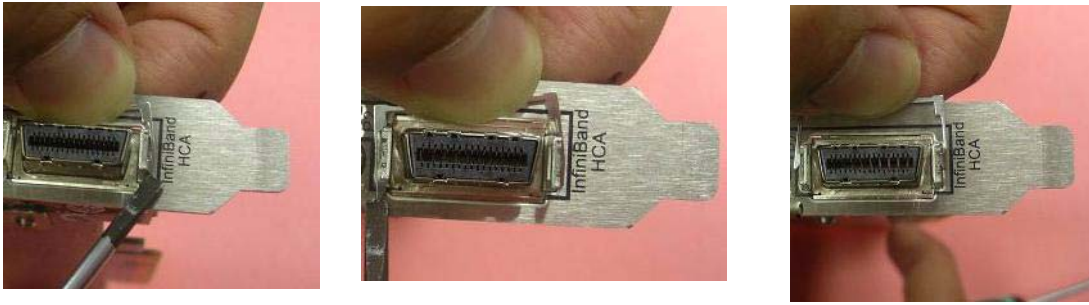

(a) Gently Push One Hook of Clip

(b) Gently Push Other Hook of Clip

(c) Pull Clip Away

3. Unscrew both screws from the card using a torque screwdriver as shown in Figure 13.

Figure 12: Unscrew Bracket Screws

These two screws hold on the bracket

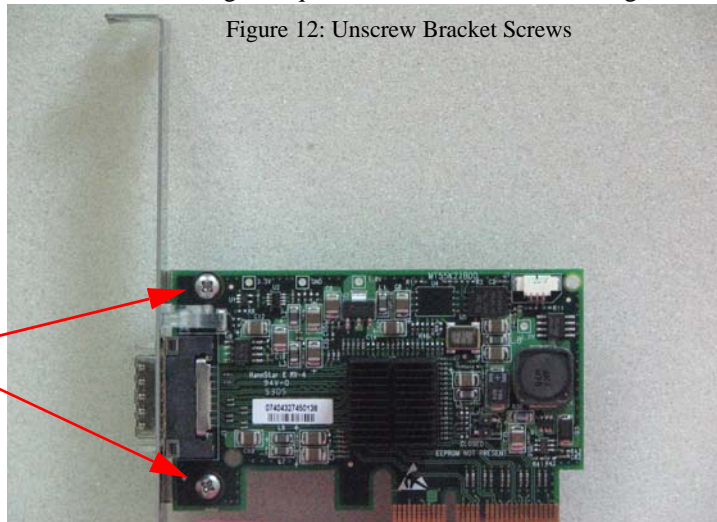

4. Grip the bracket as shown in Figure 13, placing your thumb on the LED component.
5. In a rotating move toward the component side of the card, slide the bracket out of the connector (Figure 13 (b)).
6. Gently hold your thumb on the LED component.
7. At the same time extract the bracket as shown in Figure 13 b, (Make sure to protect the LED while extracting the bracket).

Figure 13: Rotate the Bracket to Detach it From the Card

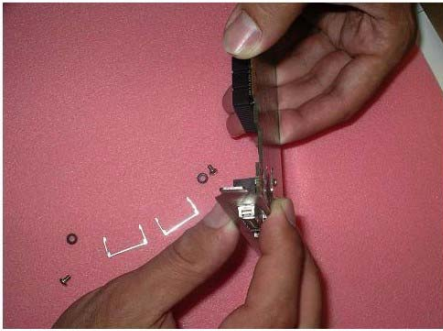

(a) Grip the Card in preparation for Detachment.

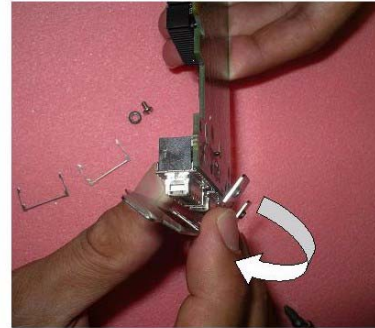

(b) Rotate the bracket toward the Component Side.



(c) Bracket Separated From Clips and Screws.

## C.2 Assembling Short Bracket

The short bracket can now be assembled onto the HCA card.

Gently place the bracket onto the card fitting the connectors through the bracket connector holes. The tab on the bracket should be pointing in the same direction as the PCI connector. Make sure the LEDs are aligned into their intended bracket holes.

2. Insert a screw along with a washer into each of the two holes on the card, intended for holding the bracket.
3. Use a torque screwdriver to apply up to 2 lbs-in torque on each screw

Figure 14: Attach Bracket onto Card using Screws



4. Gently push the clip onto the connector. Make sure to slide both clip hooks (sides) around the connector evenly as shown in Figure 15.

Figure 15: Sliding Connector Clip Evenly



5. Use a small flat head screwdriver to gently slide the clip hooks towards the connector's base side as shown in Figure 15.

Figure 16: Assembled Short Bracket View



# Appendix D: Avertissements de sécurité d'installation

## 1. Instructions d'installation



Lisez toutes les instructions d'installation avant de brancher le matériel à la source d'alimentation électrique.

## 2. Température excessive



Ce matériel ne doit pas fonctionner dans une zone avec une température ambiante dépassant le maximum recommandé de 45°C (113°F). En outre, pour garantir un bon écoulement de l'air, laissez au moins 8 cm (3 pouces) d'espace libre autour des ouvertures de ventilation.

## 3. Orages – dangers électriques



Pendant un orage, il ne faut pas utiliser le matériel et il ne faut pas brancher ou débrancher les câbles.

## 4. Branchement/débranchement des câbles InfiniBand en cuivre



Les câbles InfiniBand en cuivre sont lourds et ne sont pas flexibles, il faut donc faire très attention en les branchant et en les débranchant des connecteurs. Consultez le fabricant des câbles pour connaître les mises en garde et les instructions spéciales.

## 5. Installation du matériel



Ce matériel ne doit être installé, remplacé ou entretenu que par du personnel formé et qualifié.

## 6. Elimination du matériel



L'élimination de ce matériel doit s'effectuer dans le respect de toutes les législations et réglementations nationales en vigueur.

## 7. Codes électriques locaux et nationaux



Ce matériel doit être installé dans le respect des codes électriques locaux et nationaux.



